

# kinetik™

*Kinetik Labs  
KISP-E200-IC*

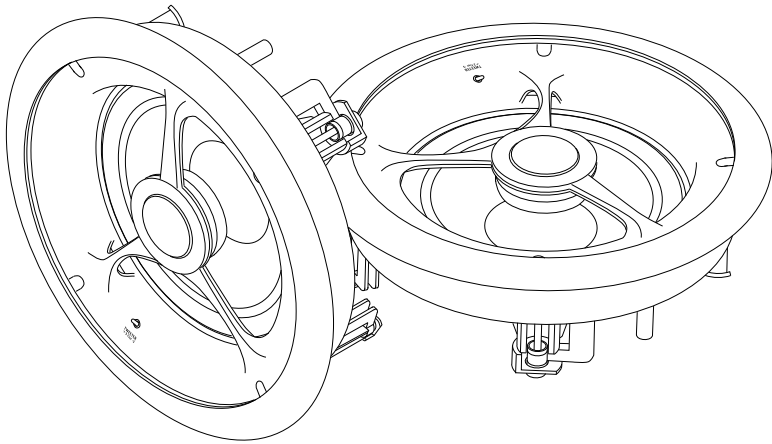

*In-Ceiling Speakers  
Instruction Manual*



*Kinetik Labs*  
*KISP-E200-IC*

*In-Ceiling Speakers*

*Contents*

<b>Section</b>	<b>Page</b>
Introduction	3
Safety Instructions	3
Description	3
Box Contents	4
Installation Instructions	5
Speaker Removal	7
Painting Speakers	7
Additional Features	8
Specifications	9
Limited Warranty	10



*Kinetik Labs*  
*KISP-E200-IC*

*In-Ceiling Speakers*

### *Introduction*

Thank you for purchasing these Kinetik Labs speakers. Please read these instructions carefully to complete your installation quickly and efficiently for trouble free installation.

### *Safety Instructions*



- **Caution:** Installation should be carried out and checked before providing power to the system. Damage caused by improper wiring or installation is not covered by the warranty.
- Keep this product away from small children and animals as it contains small parts.
- Keep this product away from naked flames and sources of ignition including lighting. Building regulations may require that you install a fire hood.

### *Description*

The KISP-E200-IC is designed for installation in ceilings, or other suitable surfaces such as plasterboard walls. It is a two way array design with 200mm Polypropylene bass/mid driver and pivotable 25mm silk dome tweeter. The tweeter can be angled 30 degrees in any direction from the centre thanks to its ball and socket design. To allow for different installation circumstances, fine tuning is possible using the +/- 3dB treble switch and the speaker impedance can also be selected as 4 or 8 Ohms.

## Box Contents

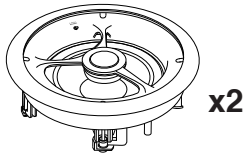

**KISP-E200-IC** In-ceiling speaker

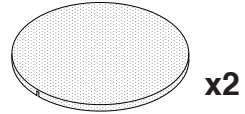

Aluminium speaker grille

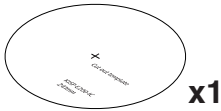

Cutout template

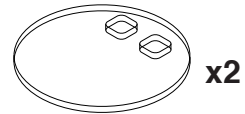

Paint guard



Speaker grille extraction tool

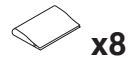

Speaker grille fixing gum



Instruction manual

## Installation Instructions

- ❗ Be careful when handling the speaker. It is okay to hold using the tweeter bridge but do not touch the drive unit as it could result in damage.

1.

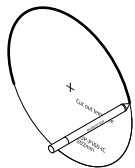

Using the cut out template, draw a 242mm circle on the ceiling / wall, where you wish to install the speaker.

- ❗ Ensure there are no joists in the way.

2.

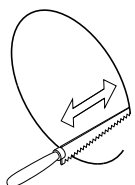

Cut out a hole using a suitable saw or hole cutting tool.

- ❗ Be careful not to cut through wiring or pipes.

3.

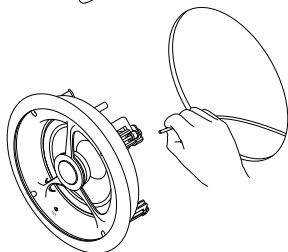

Now pull through the speaker cable and connect it to the speaker binding posts located on the rear of the speaker.

To do this, press down on each binding post and feed the bare cable wire into the hole. Releasing the binding post will lock the wire in place.

- ❗ Make sure you connect the speaker cable to the corresponding + / - outputs from the amplifier.

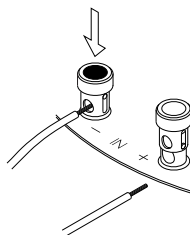

4.

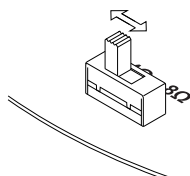

You will find the impedance switch next to the binding posts. Set this to the impedance you require.

- ❗ Consult your amplifier manual

## Installation Instructions (continued)

5.

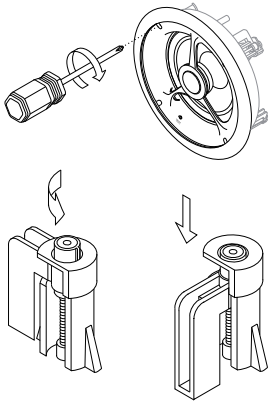

Place each speaker into the hole, with the white plastic dog legs on the rear of the speaker tucked in, and tighten the four screws with a Phillips-head screwdriver.

The dog legs will turn and lock the speaker into the ceiling / wall. The fixing should be firm but do not overtighten as this can strip the thread and cause difficulties for speaker removal.

6.

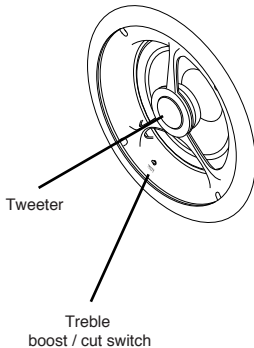

Direct the pivotable tweeter to desired position and check / modify the treble switch as required.

See 'Additional Features' section for more details about these.

7.

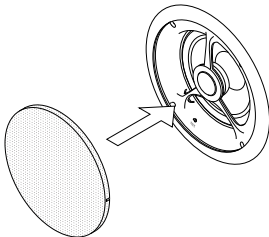

When you are happy the system is working, fix the speaker grille to the speaker. You can use the supplied fixing gum to more effectively secure the grille by placing small amounts between the grille and speaker bezel if required.

Repeat these steps for all speakers.

## Speaker Removal

1.

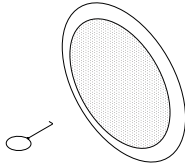

Hook the speaker grille at the edge using the speaker grille removal tool and ease it carefully off the speaker.

2.

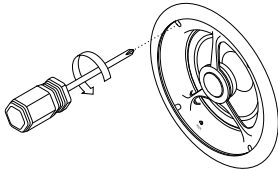

Unscrew the four screws around the speaker rim and hold it securely as it loosens. The dog legs should automatically retract.

3.

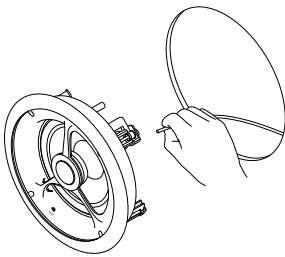

To release the speaker, gently pull it out from the hole and disconnect the speaker cable from the binding posts.

## Painting Speakers

These speakers have a paintable bezel and grille which must be decorated separately and with the correct methods to avoid directly painting or damaging the drivers.

A paint guard is provided to enable you to spray the bezel without affecting the drive units. It is essential this is used.

When spraying the grille, use suitable methods to ensure the holes are not blocked.

## Additional features

### Treble boost / cut switch

The KISP-E200-IC speakers have a switch for adjusting treble frequencies in the audio spectrum. It can be left in the central position for passive response or switched left or right for a 3 decibel boost or cut.

The choice of adjustment can be chosen by the acoustic characteristics of the room or by listener preference.

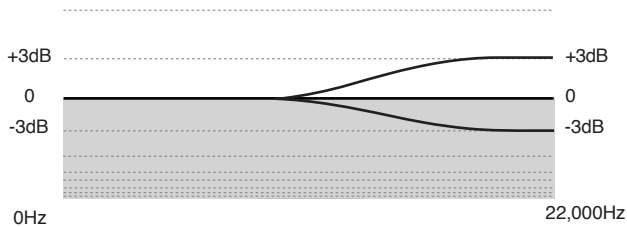

### Pivoting tweeter

The KISP-E200-IC speakers have a wide dispersion and boast a 360 degree tweeter housing, adjustable to 30 degrees off axis. This increases the variety of locations you can install each speaker and helps optimise the listening position(s).

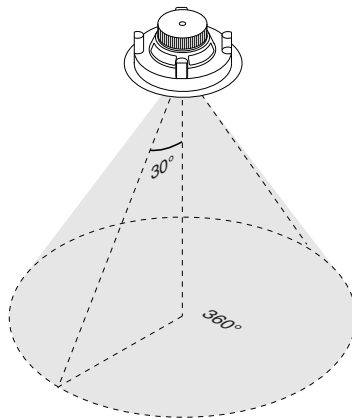

The drawings on this page are for illustration purposes.

## Specifications

### General

Model Number:	KISP-E200-IC
Box contents:	2x in-ceiling speakers 2x aluminium speaker grilles
Included accessories:	1x cut out template 2x paint guards 1x speaker grille removal tool 8x speaker grille fixing gum 1x instruction manual

### Mechanical

Woofer:	200mm polypropylene cone with mica, rubber surround, 32mm voice coil, 709g magnet, vented pole piece
Tweeter:	25mm silk dome, ferro-fluid cooled, 30 degree swivel and pivot, neodymium magnet
Tweeter protection:	Polyimide auto protective reset switch
Recommended amplification:	10-150W
Maximum power:	150W
Impedance:	4 / 8 Ohm switchable
Sensitivity:	89dB
Frequency response:	45-22,000Hz
Weight (per speaker):	2.35kg
Packed Weight:	7.14kg
Cutout size:	242mm
Mounting depth:	122mm
Maximum surface thickness:	37mm

### Dimensions

#### TOP

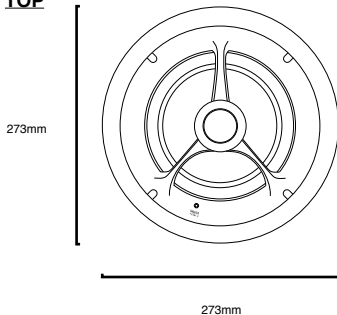

#### SIDE

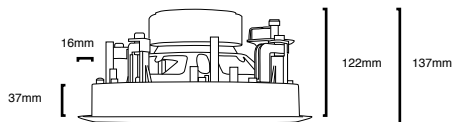

## *Limited Warranty*

This Kinetik Labs product is warranted free of defects in workmanship and materials on purchase. If the goods are found to be defective within the warranty period, they will be repaired or replaced, at AWE Europe Ltd's option, without charge on return to the vendor upon satisfactory proof of purchase from the vendor and date of purchase. This warranty does not apply if, in the judgement of AWE Europe Ltd, the product fails due to damage from shipment, handling, storage, accident, abuse, or misuse, or if it has been used or maintained in a manner not conforming to product manual instructions, has been modified in any way, or has had any serial number removed or defaced. Repair by anyone other than AWE Europe Ltd or an approved agent will void this warranty. The maximum liability of AWE Europe Ltd under this warranty is limited to the purchase price of the product covered by the warranty. AWE Europe Ltd shall not under any circumstances be liable to any person for any special, incidental, indirect or consequential damages, including without limitation, damages resulting from use or malfunction of the products, loss of profits or revenues or costs of replacement goods, even if AWE Europe Ltd is informed in advance of the possibility of such damages.

In the first instance consumers should contact their vendor.  
Territorial distributor details can be found at [www.kinetiklabs.com](http://www.kinetiklabs.com)



# kinetik™

*www.kinetiklabs.com*

© Copyright AWE Europe Ltd 2010. All rights reserved. Design and specifications are subject to change without prior notice. No part of this document may be reproduced, for any purpose, without prior written permission from AWE Europe Ltd. AWE Europe Ltd is not liable for omissions or for technical or editorial errors herein or for damages directly or indirectly resulting from the use of this Kinetik Labs product. 'Kinetik Labs' and the 'Kinetik' logo are trademarks of AWE Europe Ltd.

